

# DATA SHEET

## **TEA5710; TEA5710T** AM/FM radio receiver circuit

Product specification  
File under Integrated Circuits, IC01

March 1994

## AM/FM radio receiver circuit

## TEA5710; TEA5710T

## FEATURES

- Wide supply voltage range: 2.0 to 12 V
- Low current consumption: 7.5 mA at AM, 9.0 mA at FM
- High selectivity with distributed IF gain
- LED driver for tuning indication
- High input sensitivity: 1.6 mV/m (AM), 2.0  $\mu$ V (FM) for 26 dB S/N
- Good strong signal behaviour: 10 V/m at AM, 500 mV at FM
- Low output distortion: 0.8% at AM, 0.3% at FM
- Designed for simple and reliable PC-board layout
- High impedance MOSFET input on AM

## APPLICATIONS

- Portable AM/FM radio
- Clock radio
- Personal headphone radio

## DESCRIPTION

The TEA5710 is a high performance Bimos IC for use in AM/FM radios. All necessary functions are integrated: from AM and FM front-end to detector output stages.

## QUICK REFERENCE DATA

Conditions AM:  $f_i = 1$  MHz;  $m = 0.3$ ;  $f_m = 1$  kHz;  $V_P = 3.0$  V; measured in Fig.4 with S1 in position B and S2 in position A, unless otherwise specified. Conditions FM:  $f_i = 100$  MHz;  $\Delta f = 22.5$  kHz;  $f_m = 1$  kHz;  $V_P = 3.0$  V; measured in Fig.4 with S1 in position B and S2 in position A, unless otherwise specified.

SYMBOL	PARAMETER	MIN.	TYP.	MAX.	UNIT
$V_P$	positive supply voltage	2.0	–	12	V
$I_P$	supply current				
	in AM mode	5.6	7.5	9.9	mA
	in FM mode	7.3	9.0	11.2	mA
$T_{amb}$	operating ambient temperature range	–15	–	+60	$^{\circ}$ C
<b>AM performance</b>					
$V_{in1}$	RF sensitivity	40	55	70	$\mu$ V
$V_{13}$	AF output voltage	36	45	70	mV
THD	total harmonic distortion	–	0.8	2.0	%
<b>FM performance</b>					
$V_{in3}$	RF sensitivity	1.0	2.0	3.8	$\mu$ V
$V_{13}$	AF output voltage	47	58	69	mV
THD	total harmonic distortion	–	0.3	0.8	%

## ORDERING INFORMATION

EXTENDED TYPE NUMBER	PACKAGE			
	PINS	PIN POSITION	MATERIAL	CODE
TEA5710	24	SDIL	plastic	SOT234AG <sup>(1)</sup>
TEA5710T	24	SO24L	plastic	SOT137A <sup>(2)</sup>

## Notes

1. SOT234-1; 1996 August 27.
2. SOT137-1; 1996 August 27.

AM/FM radio receiver circuit

TEA5710; TEA5710T

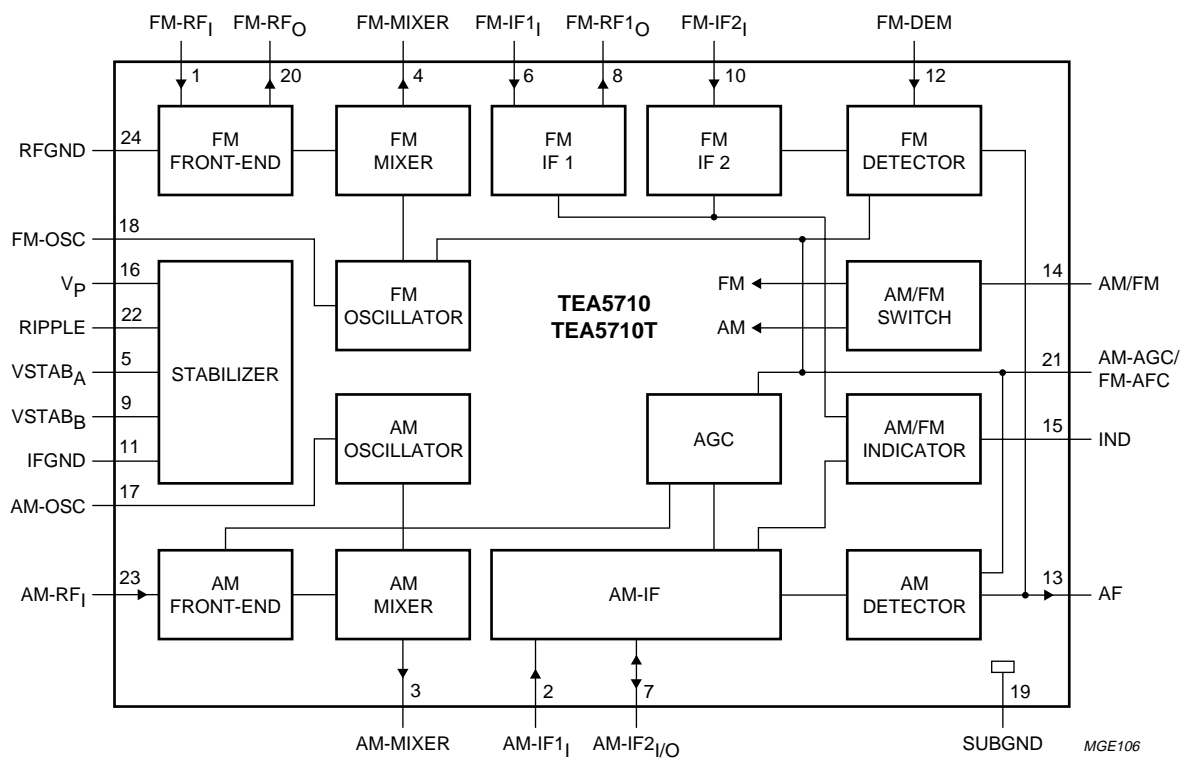

Fig.1 Block diagram.

## AM/FM radio receiver circuit

## TEA5710; TEA5710T

## PINNING

SYMBOL	PIN	DESCRIPTION
FM-RF <sub>I</sub>	1	FM-RF aerial input (input impedance typ. 50 Ω)
AM-IF1 <sub>I</sub>	2	input from IFT or ceramic filter (input impedance typ. 3 kΩ)
AM-MIXER	3	open-collector output to IFT
FM-MIXER	4	output to ceramic IF filter (output impedance typ. 330 Ω)
VSTAB <sub>A</sub>	5	stabilized internal supply voltage (A)
FM-IF1 <sub>I</sub>	6	first FM-IF input (input impedance typ. 330 Ω)
AM-IF2 <sub>I/O</sub>	7	input/output to IFT; output: current source
FM-IF1 <sub>O</sub>	8	first FM-IF output (output impedance typ. 330 Ω)
VSTAB <sub>B</sub>	9	stabilized internal supply voltage (B)
FM-IF2 <sub>I</sub>	10	second FM-IF input (input impedance typ. 330 Ω)
IFGND	11	ground of IF and detector stages
FM-DEM	12	ceramic discriminator pin
AF	13	audio output (output impedance typ. 5 kΩ)
AM/FM	14	switch terminal: open for AM; ground for FM
IND	15	field-strength dependent indicator
V <sub>P</sub>	16	positive supply voltage
AM-OSC	17	parallel tuned AM-OSC circuit to ground
FM-OSC	18	parallel tuned FM-OSC circuit to ground
SUBGND	19	substrate and RF ground
FM-RF <sub>O</sub>	20	parallel tuned FM-RF circuit to ground
AM-AGC/FM-AFC	21	AGC/AFC capacitor pin
RIPPLE	22	ripple capacitor pin
AM-RF <sub>I</sub>	23	parallel tuned AM aerial circuit to ground (total input capacitance typ. 3 pF)
RFGND	24	FM-RF ground

AM/FM radio receiver circuit

TEA5710; TEA5710T

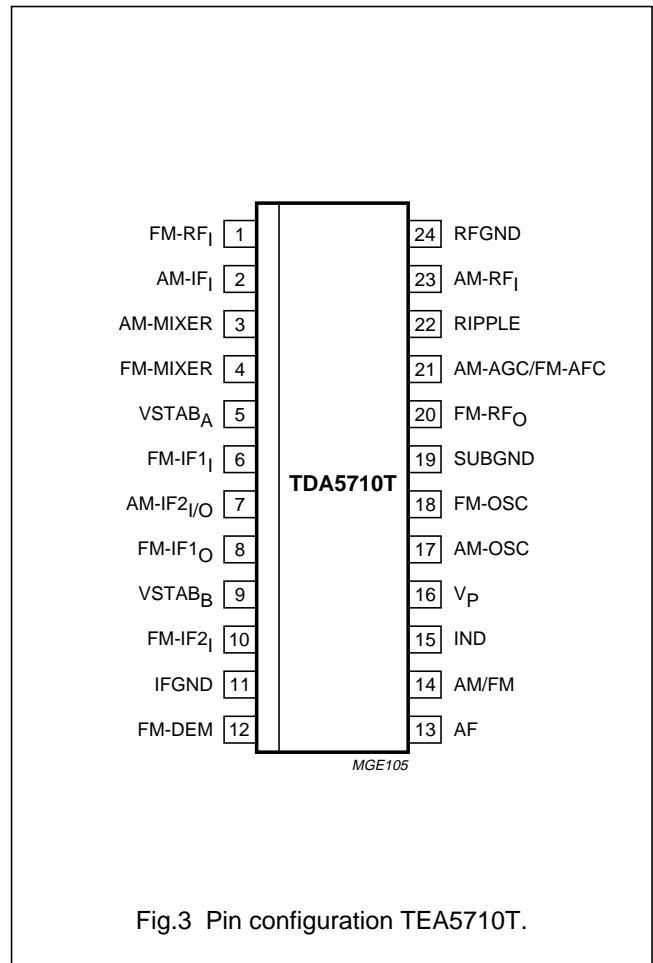
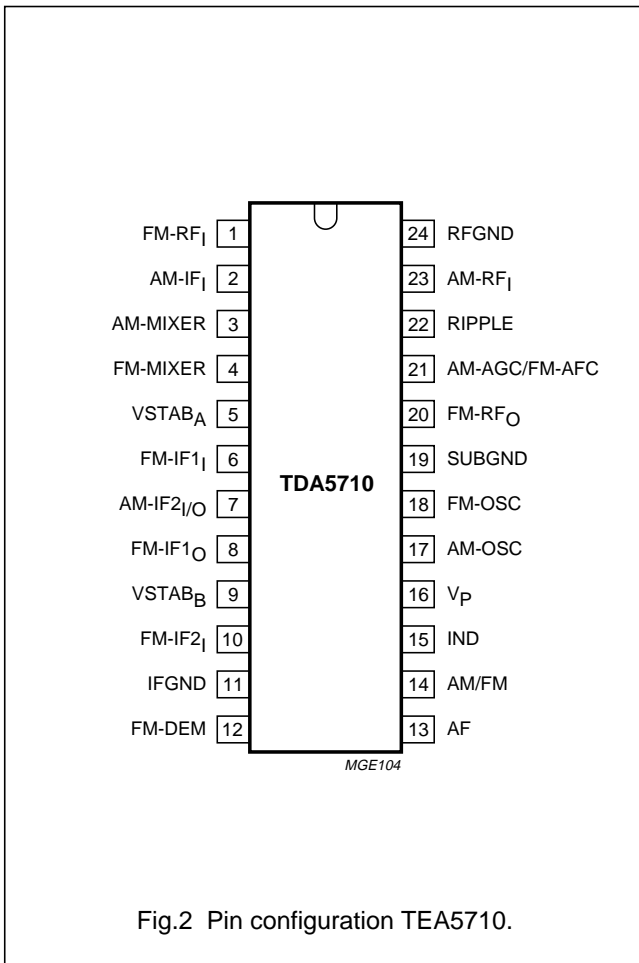

**FUNCTIONAL DESCRIPTION**

The TEA5710 incorporates internal stabilized power supplies. The maximum supply voltage is 12 V, the minimum voltage can go down temporarily to 1.8 V without any loss in performance.

The AM circuit incorporates a double balanced mixer, a one pin low-voltage oscillator (up to 30 MHz), a field-strength dependent indicator output and is designed for distributed selectivity.

The AM input is designed to be connected to the top of a tuned circuit. AGC controls the IF amplification and for large signals it lowers the input impedance.

The first AM selectivity can be an IFT as well as an IFT combined with a ceramic filter; the second one is an IFT.

The FM circuit incorporates a tuned RF stage, a double balanced mixer, a one-pin oscillator, a field-strength indicator output and is designed for distributed IF ceramic filters. The FM quadrature detector uses a ceramic resonator.

AM/FM radio receiver circuit

TEA5710; TEA5710T

**LIMITING VALUES**

In accordance with the Absolute Maximum Rating System (IEC 134)

SYMBOL	PARAMETER	MIN.	MAX.	UNIT
V <sub>P</sub>	positive supply voltage	0	12	V
T <sub>stg</sub>	storage temperature range	-55	+150	°C
T <sub>amb</sub>	operating ambient temperature range	-15	+60	°C
T <sub>j</sub>	junction temperature range	-15	+150	°C

**THERMAL RESISTANCE**

SYMBOL	PARAMETER	VALUE	UNIT
R <sub>th j-a</sub>	from junction to ambient for SDIL version TEA5710 for SO24L version TEA5710T	69 76	K/W K/W

**CIRCUIT DESIGN DATA**

PIN NO.	PIN SYMBOL	DC PIN VOLTAGE (V)		EQUIVALENT CIRCUIT
		AM	FM	
1	FM-RF <sub>I</sub>	-	0.73	
2	AM-IF1 <sub>I</sub> input	1.4	1.4	

AM/FM radio receiver circuit

TEA5710; TEA5710T

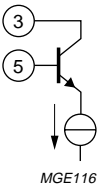
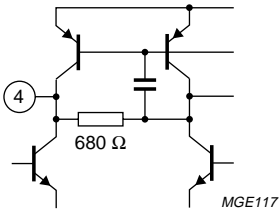
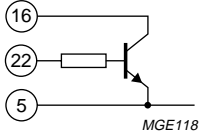
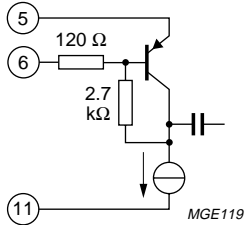
PIN NO.	PIN SYMBOL	DC PIN VOLTAGE (V)		EQUIVALENT CIRCUIT
		AM	FM	
3	AM-MIXER output	1.4	1.4	 <p>MGE116</p>
4	FM-MIXER output	–	1.0	 <p>MGE117</p>
5	VSTAB <sub>A</sub>	1.4	1.4	 <p>MGE118</p>
6	FM-IF <sub>1</sub> input	–	0.73	 <p>MGE119</p>

AM/FM radio receiver circuit

TEA5710; TEA5710T

PIN NO.	PIN SYMBOL	DC PIN VOLTAGE (V)		EQUIVALENT CIRCUIT
		AM	FM	
7	AM-IF2 <sub>I/O</sub> input/output	1.4	1.4	<p>MGE120</p>
8	FM-IF1 <sub>O</sub> output	–	0.69	<p>MGE121</p>
9	VSTAB <sub>B</sub>	1.4	1.4	<p>MGE122</p>
10	FM-IF2 <sub>I</sub> input	–	0.73	<p>MGE123</p>
11	IFGND	0	0	



AM/FM radio receiver circuit

TEA5710; TEA5710T

PIN NO.	PIN SYMBOL	DC PIN VOLTAGE (V)		EQUIVALENT CIRCUIT
		AM	FM	
12	FM-DEM	-	1.0	
13	AF output	0.6	0.7	
14	AM/FM switch	1.3	0	
15	IND	3.0	3.0	
16	V <sub>P</sub>	3.0	3.0	
17	AM-OSC	0	0	

AM/FM radio receiver circuit

TEA5710; TEA5710T

PIN NO.	PIN SYMBOL	DC PIN VOLTAGE (V)		EQUIVALENT CIRCUIT
		AM	FM	
18	FM-OSC	0	0	
19	SUBGND	0	0	
20	FM-RF <sub>O</sub>	0	0	
21	AM-AGC/ FM-AFC	0.1	0.7	

AM/FM radio receiver circuit

TEA5710; TEA5710T

PIN NO.	PIN SYMBOL	DC PIN VOLTAGE (V)		EQUIVALENT CIRCUIT
		AM	FM	
22	RIPPLE	2.1	2.1	
23	AM-RF <sub>I</sub>	0	0	
24	RFGND	0	0	

## AM/FM radio receiver circuit

## TEA5710; TEA5710T

**AM CHARACTERISTICS**

$f_i = 1$  MHz;  $m = 0.3$ ;  $f_m = 1$  kHz;  $V_P = 3.0$  V; measured in Fig.4 with S1 in position B and S2 in position A, unless otherwise specified.

SYMBOL	PARAMETER	CONDITIONS	MIN.	TYP.	MAX.	UNIT
$I_P$	supply current	no input signal	5.6	7.5	9.9	mA
$C_i$	input capacitance	$V_{21} = 0.2$ V	–	3	–	pF
$G_c$	front-end conversion gain	$V_{21} = 0.2$ V	1.8	3.3	5.0	
$V_{in1}$	RF sensitivity	S/N = 26 dB	40	55	70	$\mu$ V
$V_{in2}$	IF sensitivity	$V_{13} = 30$ mV; S <sub>1</sub> in position A	0.13	0.2	0.45	mV
$V_{13}$	AF output voltage	$V_{in2} = 3.16$ mV; S <sub>1</sub> in position A	36	45	70	mV
THD	total harmonic distortion	$V_{in1} = 1$ mV	–	0.8	2.0	%
$V_{in1}$	large signal handling	$m = 0.8$ ; THD $\leq 8\%$	150	300	–	mV
$I_{IND}$	indicator current	$V_{in2} = 100$ mV; S <sub>1</sub> in position A	2	3.5	6	mA
$I_{INDOFF}$	indicator OFF current	$V_{in2} = 0$ V; S <sub>1</sub> in position A	–	0	10	$\mu$ A

**FM CHARACTERISTICS**

$f_i = 100$  MHz;  $\Delta f = 22.5$  kHz;  $f_m = 1$  kHz;  $V_P = 3.0$  V; measured in Fig.4 with S1 in position B and S2 in position A, unless otherwise specified.

SYMBOL	PARAMETER	CONDITIONS	MIN.	TYP.	MAX.	UNIT
$I_P$	supply current	no input signal	7.3	9.0	11.2	mA
$V_{in3}$	RF limiting sensitivity	$V_{13} = -3$ dB	0.4	1.2	3.8	$\mu$ V
$V_{in3}$	RF sensitivity	S/N = 26 dB	1.0	2.0	3.8	$\mu$ V
$V_6/V_{in3}$	front-end voltage gain	$V_{in3} \leq 1$ mV; including ceramic filter K1	12	18	22	dB
$V_{in4}$	IF sensitivity	S <sub>2</sub> in position B; $V_{13} = -3$ dB	–	20	30	$\mu$ V
$V_{13}$	AF output voltage	$V_{in3} = 1$ mV	47	58	69	mV
THD	total harmonic distortion	$V_{in3} = 1$ mV; $\Delta f = 22.5$ kHz	–	0.3	0.8	%
$V_{in3}$	large signal handling	THD $\leq 5\%$	–	500	–	mV
$I_{IND}$	indicator current	$V_{in4} = 100$ mV; S <sub>2</sub> in position B	2	3.5	6	mA
$I_{INDOFF}$	indicator OFF current	$V_{in4} = 0$ V; S <sub>2</sub> in position B	–	0	10	$\mu$ A

AM/FM radio receiver circuit

TEA5710; TEA5710T

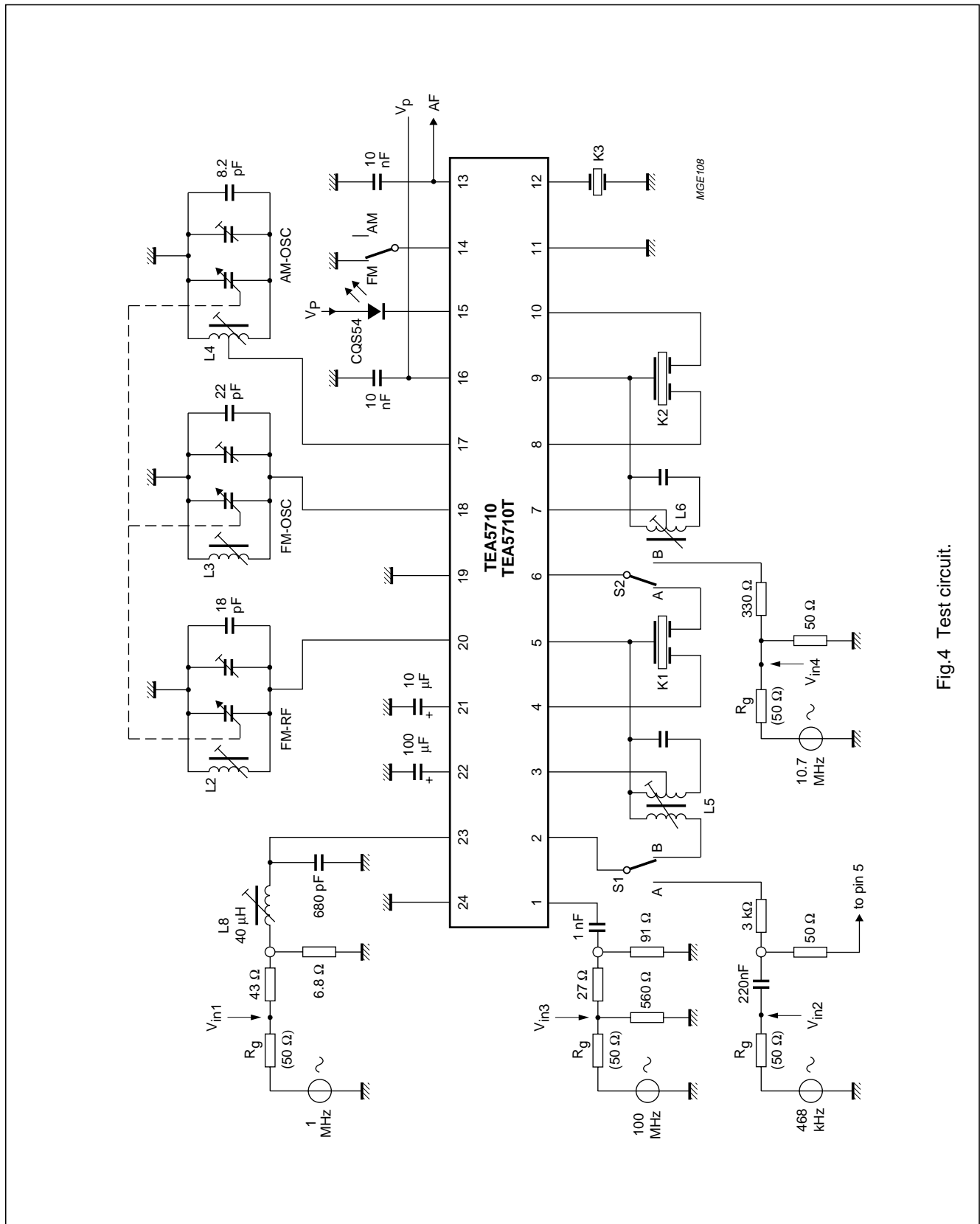
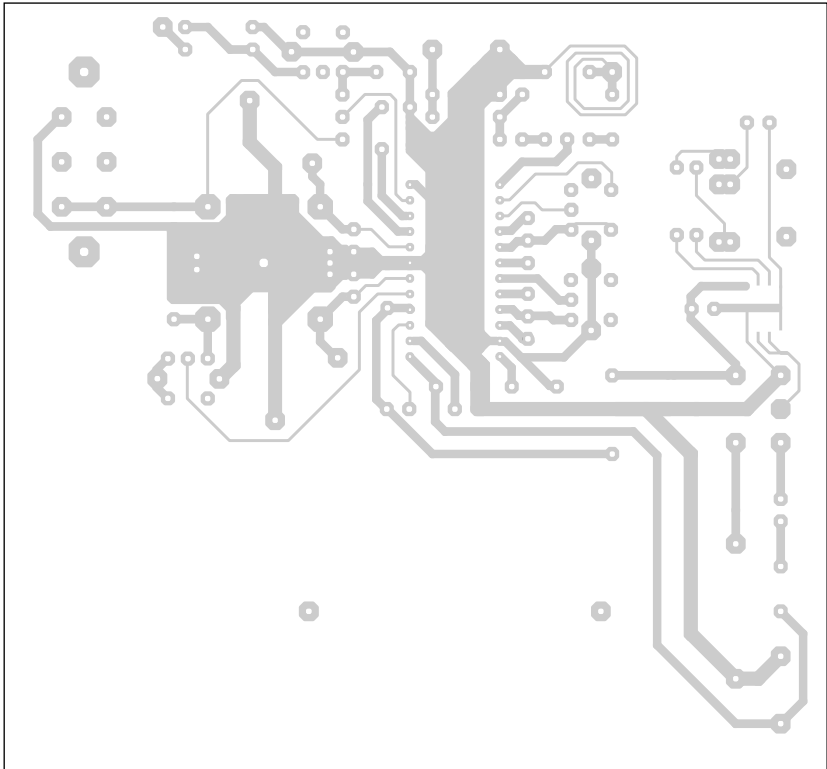

Fig.4 Test circuit.



AM/FM radio receiver circuit

TEA5710; TEA5710T



MGE109

Fig.6 Printed-circuit board layout (track side) for application circuit of Fig.5.

AM/FM radio receiver circuit

TEA5710; TEA5710T

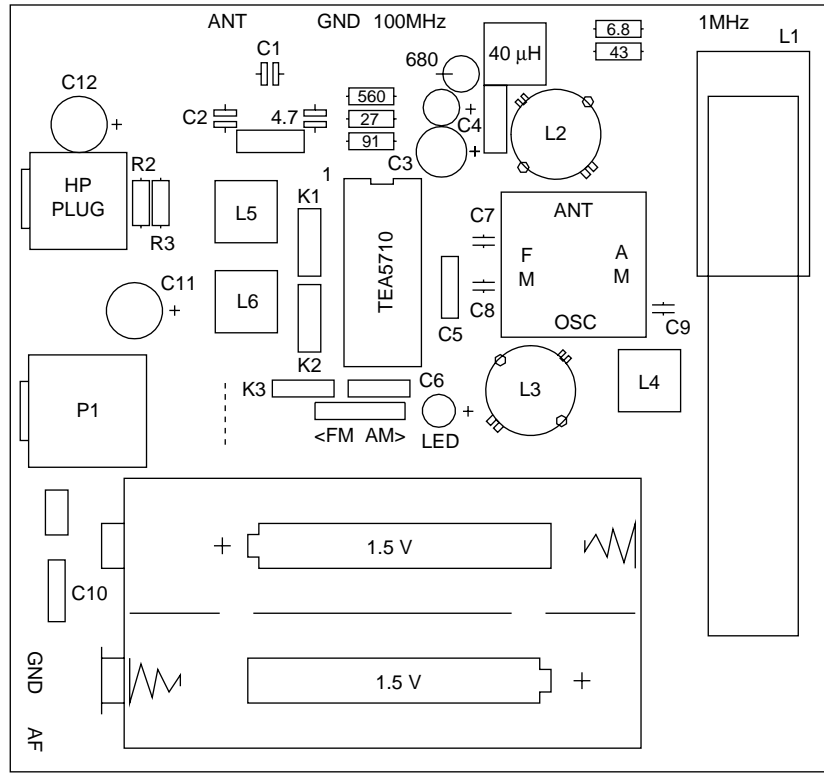

MGE110

Fig.7 Printed-circuit board layout (component side) for application circuit of Fig.5.



AM/FM radio receiver circuit

TEA5710; TEA5710T

Components for Figs 4 and 5

Coils			
L1	AM-AERIAL	ferroceptor length = 6 cm L1-2 = 625 $\mu$ H N1-2 = 105 turns	
L2	FM-RF	L1-2 = 66 nH N1-2 = 2.5 turns unloaded Q = 150 TOKO type S18 TOKO no. 301SS-0200	
L3	FM-OSC	L1-2 = 40 nH N1-2 = 1.5 turns unloaded Q = 150 TOKO type S18 TOKO no. 301SS-0100	
L4	AM-OSC	L1-3 = 270 $\mu$ H N1-2 = 18 N2-3 = 70 unloaded Q = 100 wire diameter 0.07 mm TOKO type 7P material TOKO 7BRS	
L5	AM-IF1	L1-3 = 625 $\mu$ H N1-2 = 17 turns N2-3 = 141 turns N4-6 = 10 turns C1-3 = 180 pF unloaded Q = 90 wire diameter 0.07 mm TOKO type 7P material TOKO 7MCS	
L6	AM-IF2	L1-3 = 625 $\mu$ H N1-2 = 28 turns N2-3 = 130 turns C1-3 = 180 pF unloaded Q = 90 wire diameter 0.07 mm TOKO type 7P material TOKO 7MCS	

AM/FM radio receiver circuit

TEA5710; TEA5710T

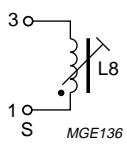
L7	FM-AERIAL	print-coil L1-2 = 60 nH N1-2 = 2.5 turns	
L8	AM-RF	test circuit only: L1-3 = 40 μH N1-3 = 34 turns unloaded Q = 85 wire diameter 0.09 mm TOKO type 7P material TOKO 7BRS	
<b>Ceramic filters</b>			
K1	FM-IF1	Murata SFE 10.7 MS 3	
K2	FM-IF2	Murata SFE 10.7 MS 2	
K3	FM-DET	Murata CDA 10.7 MC 40	
<b>Capacitors</b>			
C1	VARICON	AM: 140/82 pF FM: 2 × 20 pF trimmer: 4 × 8 pF TOKO type no. HU-22124	

**Application notes**

1. Short circuiting: **all** pins are short-circuit proof except **pin 1** (FM-RF<sub>I</sub>) with respect to the supply voltage pin.
2. Tuning indicator (at pin 15, IND): connect either a tuning indicator (e.g. a LED) between this pin and the supply voltage (pin 16) or connect the pin IND to ground.
3. For an example of PC-board layout: see Figs 6 and 7.

AM/FM radio receiver circuit

TEA5710; TEA5710T

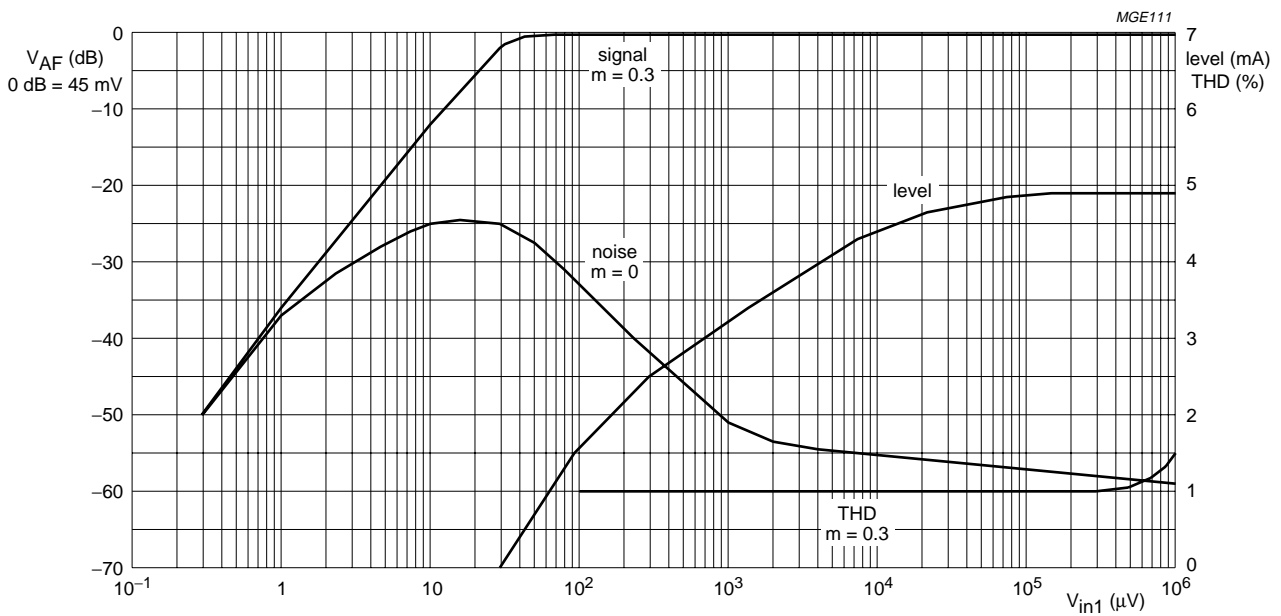

Fig.8 Typical AM audio output voltage ( $V_{AF}$ ; signal at  $m = 0.3$ ), noise, THD (at  $m = 0.3$ ) and indicator current (level) as a function of RF input voltage ( $V_{in1}$ ;  $f = 1$  kHz). Measured in test circuit of Fig.4 with  $V_P = 3.0$  V.

AM/FM radio receiver circuit

TEA5710; TEA5710T

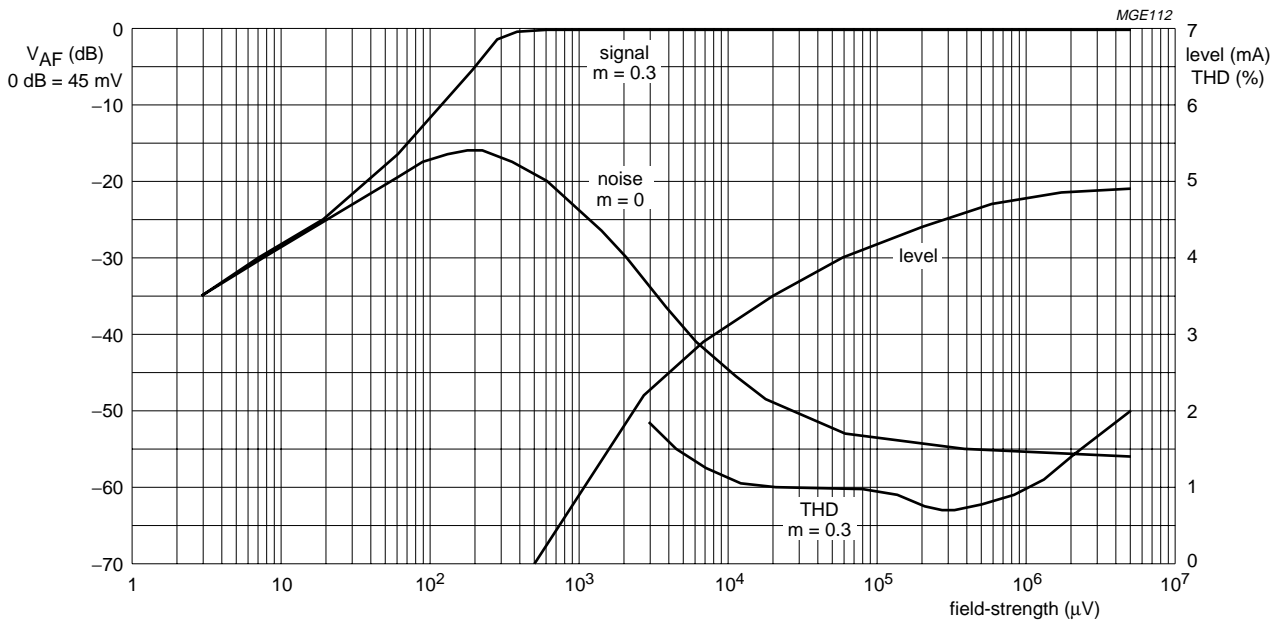

Fig.9 Typical AM audio output voltage ( $V_{AF}$ ; signal at  $m = 0.3$ ), noise, THD (at  $m = 0.3$ ) and indicator current (level) as a function of field-strength ( $f = 1$  kHz). Measured at 1 MHz in application circuit of Fig.5 with  $V_P = 3$  V.

AM/FM radio receiver circuit

TEA5710; TEA5710T

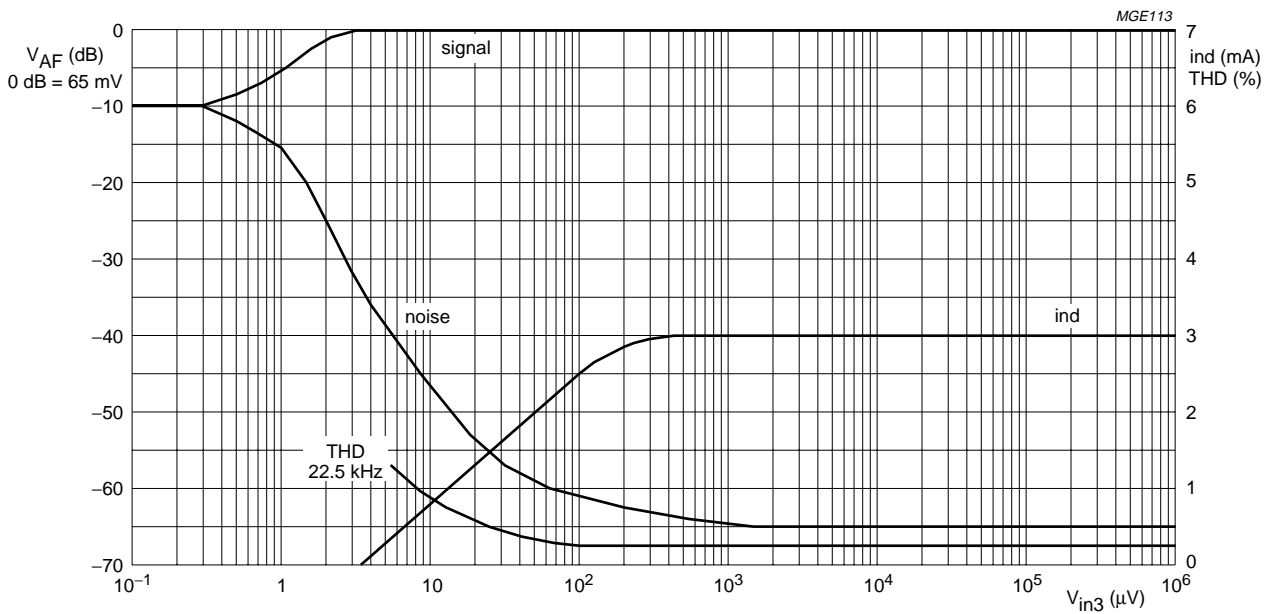

Fig.10 Typical FM audio output voltage ( $V_{AF}$ ; signal), noise, THD and indicator current (ind) as a function of RF input voltage ( $V_{in3}$ ;  $d_f = 22.5$  kHz). Measured in test circuit of Fig.4 at  $V_P = 3$  V.

AM/FM radio receiver circuit

TEA5710; TEA5710T

PACKAGE OUTLINES

SDIP24: plastic shrink dual in-line package; 24 leads (400 mil)

SOT234-1

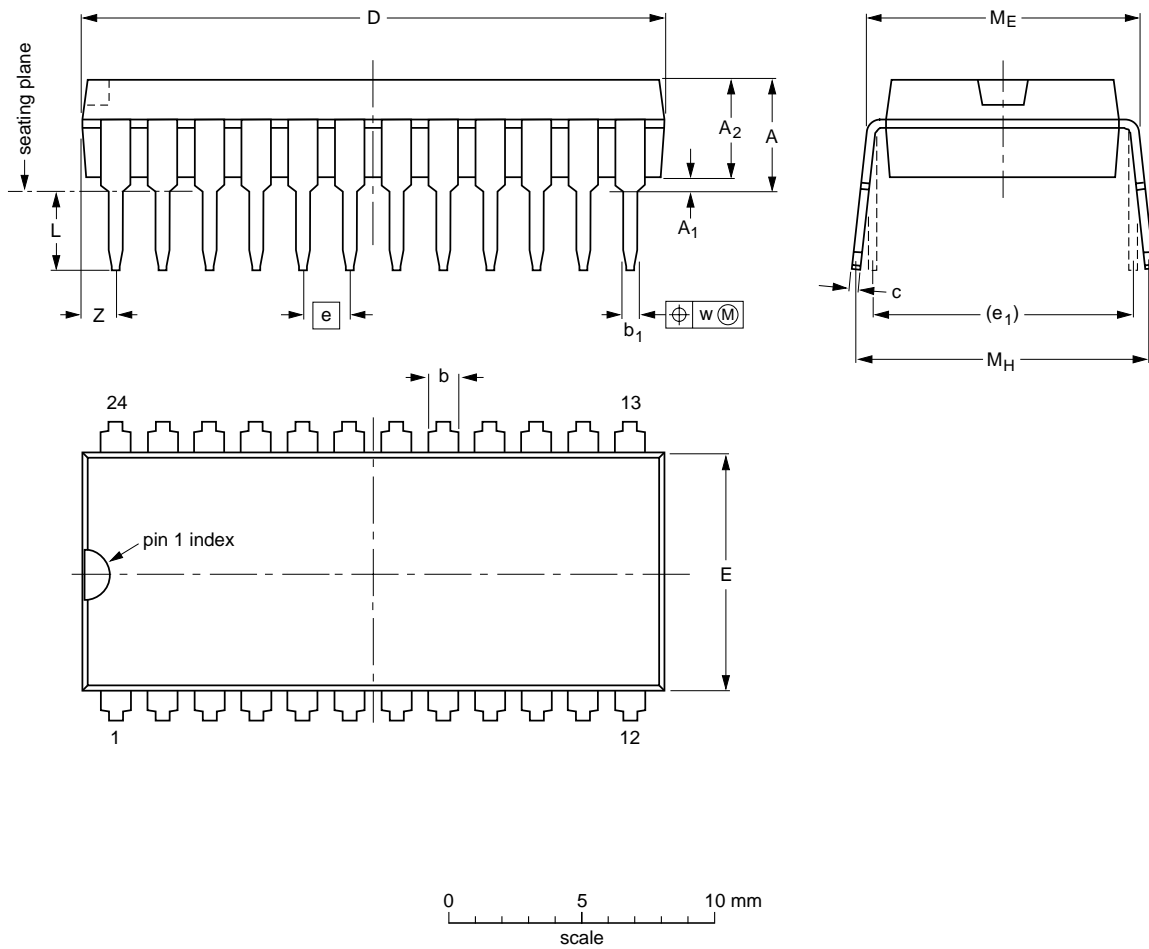

DIMENSIONS (mm are the original dimensions)

UNIT	A max.	A <sub>1</sub> min.	A <sub>2</sub> max.	b	b <sub>1</sub>	c	D <sup>(1)</sup>	E <sup>(1)</sup>	e	e <sub>1</sub>	L	M <sub>E</sub>	M <sub>H</sub>	w	Z <sup>(1)</sup> max.
mm	4.7	0.51	3.8	1.3 0.8	0.53 0.40	0.32 0.23	22.3 21.4	9.1 8.7	1.778	10.16	3.2 2.8	10.7 10.2	12.2 10.5	0.18	1.6

Note

1. Plastic or metal protrusions of 0.25 mm maximum per side are not included.

OUTLINE VERSION	REFERENCES				EUROPEAN PROJECTION	ISSUE DATE
	IEC	JEDEC	EIAJ			
SOT234-1						92-11-17 95-02-04

AM/FM radio receiver circuit

TEA5710; TEA5710T

SO24: plastic small outline package; 24 leads; body width 7.5 mm

SOT137-1

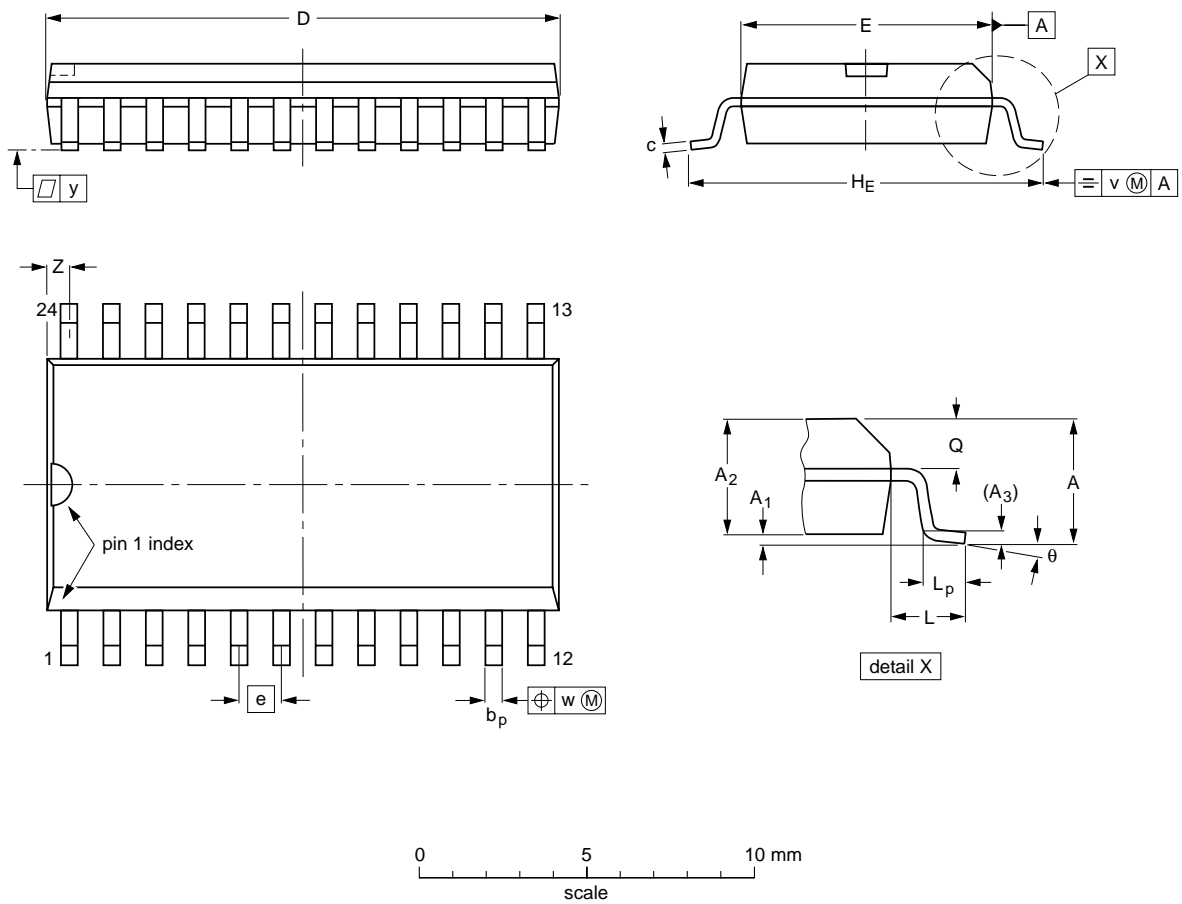

DIMENSIONS (inch dimensions are derived from the original mm dimensions)

UNIT	A max.	A <sub>1</sub>	A <sub>2</sub>	A <sub>3</sub>	b <sub>p</sub>	c	D <sup>(1)</sup>	E <sup>(1)</sup>	e	H <sub>E</sub>	L	L <sub>p</sub>	Q	v	w	y	z <sup>(1)</sup>	θ
mm	2.65	0.30 0.10	2.45 2.25	0.25	0.49 0.36	0.32 0.23	15.6 15.2	7.6 7.4	1.27	10.65 10.00	1.4	1.1 0.4	1.1 1.0	0.25	0.25	0.1	0.9 0.4	8° 0°
inches	0.10	0.012 0.004	0.096 0.089	0.01	0.019 0.014	0.013 0.009	0.61 0.60	0.30 0.29	0.050	0.419 0.394	0.055	0.043 0.016	0.043 0.039	0.01	0.01	0.004	0.035 0.016	

Note

1. Plastic or metal protrusions of 0.15 mm maximum per side are not included.

OUTLINE VERSION	REFERENCES				EUROPEAN PROJECTION	ISSUE DATE
	IEC	JEDEC	EIAJ			
SOT137-1	075E05	MS-013AD				95-01-24 97-05-22

## AM/FM radio receiver circuit

## TEA5710; TEA5710T

**SOLDERING****Introduction**

There is no soldering method that is ideal for all IC packages. Wave soldering is often preferred when through-hole and surface mounted components are mixed on one printed-circuit board. However, wave soldering is not always suitable for surface mounted ICs, or for printed-circuits with high population densities. In these situations reflow soldering is often used.

This text gives a very brief insight to a complex technology. A more in-depth account of soldering ICs can be found in our "IC Package Databook" (order code 9398 652 90011).

**SDIP**

## SOLDERING BY DIPPING OR BY WAVE

The maximum permissible temperature of the solder is 260 °C; solder at this temperature must not be in contact with the joint for more than 5 seconds. The total contact time of successive solder waves must not exceed 5 seconds.

The device may be mounted up to the seating plane, but the temperature of the plastic body must not exceed the specified maximum storage temperature ( $T_{stg\ max}$ ). If the printed-circuit board has been pre-heated, forced cooling may be necessary immediately after soldering to keep the temperature within the permissible limit.

## REPAIRING SOLDERED JOINTS

Apply a low voltage soldering iron (less than 24 V) to the lead(s) of the package, below the seating plane or not more than 2 mm above it. If the temperature of the soldering iron bit is less than 300 °C it may remain in contact for up to 10 seconds. If the bit temperature is between 300 and 400 °C, contact may be up to 5 seconds.

**SO**

## REFLOW SOLDERING

Reflow soldering techniques are suitable for all SO packages.

Reflow soldering requires solder paste (a suspension of fine solder particles, flux and binding agent) to be applied to the printed-circuit board by screen printing, stencilling or pressure-syringe dispensing before package placement.

Several techniques exist for reflowing; for example, thermal conduction by heated belt. Dwell times vary between 50 and 300 seconds depending on heating method. Typical reflow temperatures range from 215 to 250 °C.

Preheating is necessary to dry the paste and evaporate the binding agent. Preheating duration: 45 minutes at 45 °C.

## WAVE SOLDERING

Wave soldering techniques can be used for all SO packages if the following conditions are observed:

- A double-wave (a turbulent wave with high upward pressure followed by a smooth laminar wave) soldering technique should be used.
- The longitudinal axis of the package footprint must be parallel to the solder flow.
- The package footprint must incorporate solder thieves at the downstream end.

During placement and before soldering, the package must be fixed with a droplet of adhesive. The adhesive can be applied by screen printing, pin transfer or syringe dispensing. The package can be soldered after the adhesive is cured.

Maximum permissible solder temperature is 260 °C, and maximum duration of package immersion in solder is 10 seconds, if cooled to less than 150 °C within 6 seconds. Typical dwell time is 4 seconds at 250 °C.

A mildly-activated flux will eliminate the need for removal of corrosive residues in most applications.

## REPAIRING SOLDERED JOINTS

Fix the component by first soldering two diagonally-opposite end leads. Use only a low voltage soldering iron (less than 24 V) applied to the flat part of the lead. Contact time must be limited to 10 seconds at up to 300 °C. When using a dedicated tool, all other leads can be soldered in one operation within 2 to 5 seconds between 270 and 320 °C.



## AM/FM radio receiver circuit

## TEA5710; TEA5710T

**DEFINITIONS**

<b>Data sheet status</b>	
Objective specification	This data sheet contains target or goal specifications for product development.
Preliminary specification	This data sheet contains preliminary data; supplementary data may be published later.
Product specification	This data sheet contains final product specifications.
<b>Limiting values</b>	
Limiting values given are in accordance with the Absolute Maximum Rating System (IEC 134). Stress above one or more of the limiting values may cause permanent damage to the device. These are stress ratings only and operation of the device at these or at any other conditions above those given in the Characteristics sections of the specification is not implied. Exposure to limiting values for extended periods may affect device reliability.	
<b>Application information</b>	
Where application information is given, it is advisory and does not form part of the specification.	

**LIFE SUPPORT APPLICATIONS**

These products are not designed for use in life support appliances, devices, or systems where malfunction of these products can reasonably be expected to result in personal injury. Philips customers using or selling these products for use in such applications do so at their own risk and agree to fully indemnify Philips for any damages resulting from such improper use or sale.